

# Best Practices for Adopting SOA

**Oracle Architect Forums, February 2005**

Edwin Khodabakchian, VP Product Development

[edwin.khodabakchian@oracle.com](mailto:edwin.khodabakchian@oracle.com)



# SOA

## Defined

# Customer Murmurs...

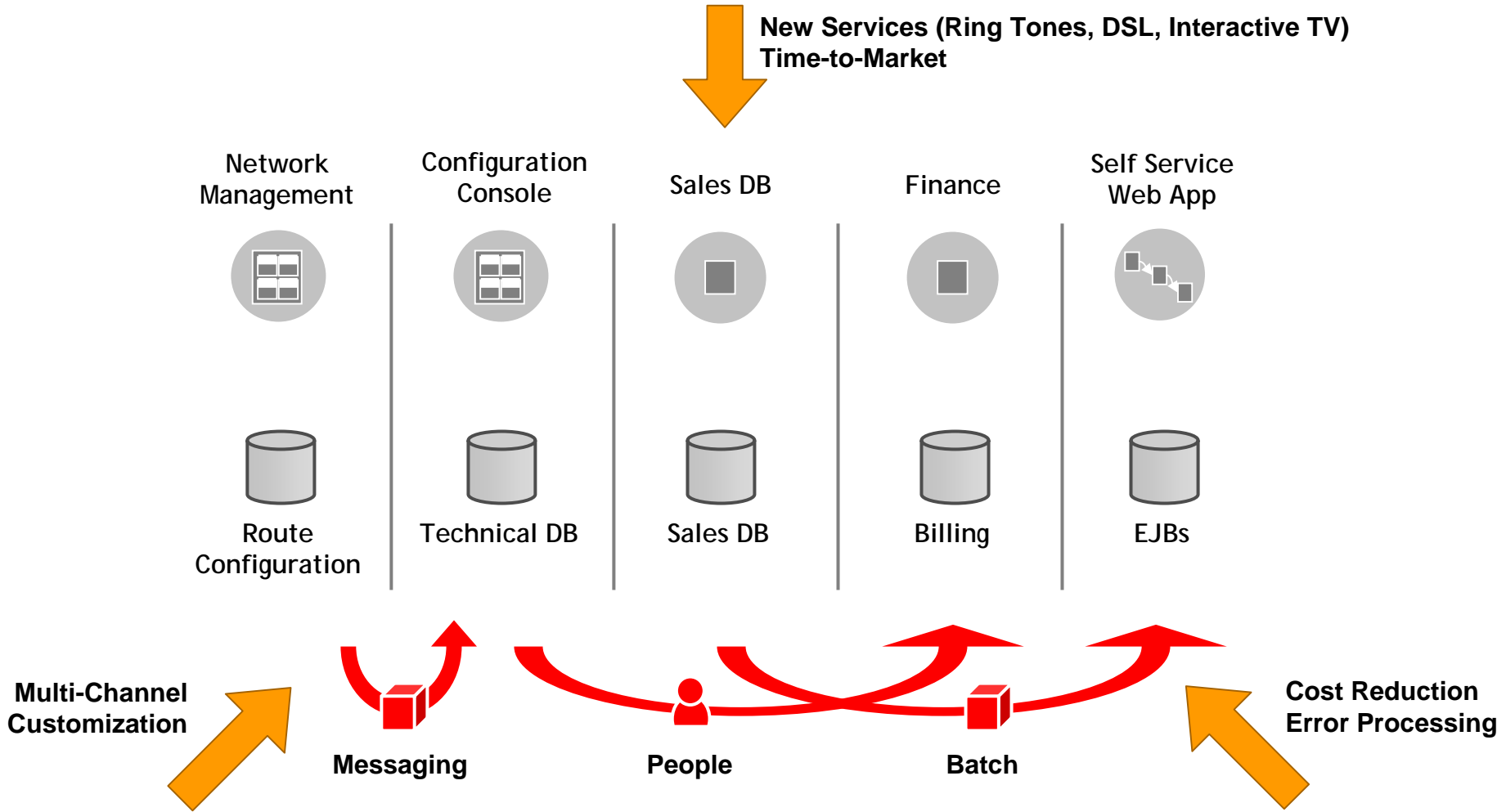

# Customer Murmurs...



Functional Analyst



## Requirements

- Functional/Business Savvy Developer
- Leverage/Façade Existing IT Assets
- Build-to-change
- Security
- Manageability
- Performance

## Why Now?

- Network Infrastructure is in place
- Standards (REST, XML, WSDL, WS-\*)
- Support from Packaged Applications

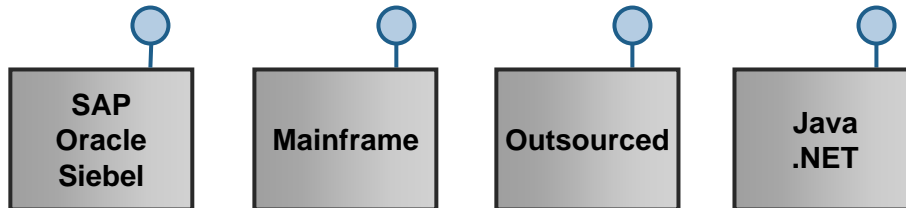

Developers

# SOA | Key Standards

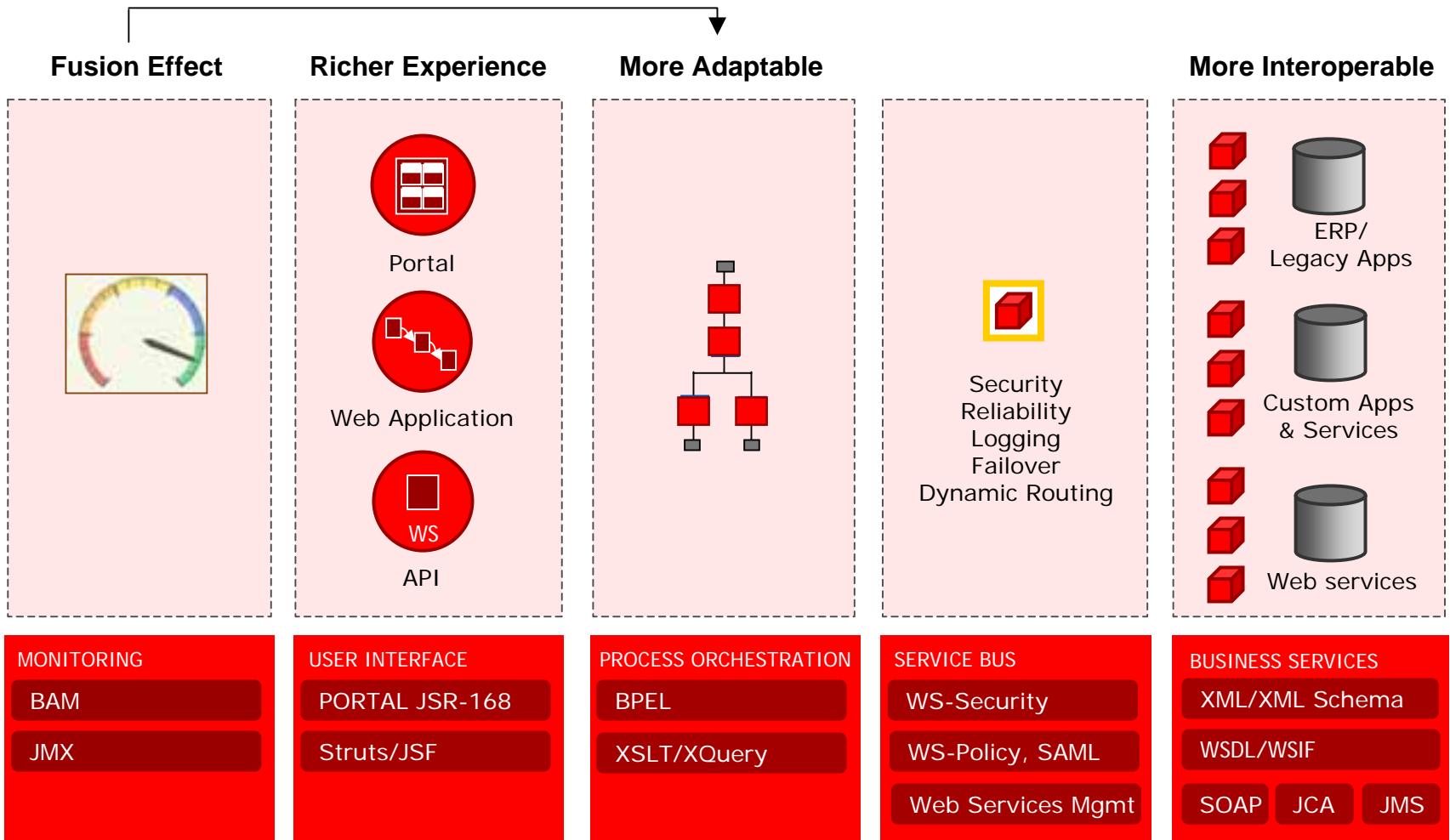

# SOA | From Simple to Sophisticated

## Portal and Legacy Wrapping

- Customer Support Dashboard
- Energy Schedule Trading

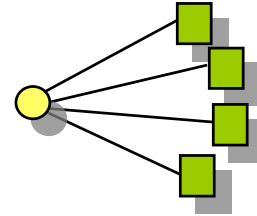

## Aggregates/Micro Flows

- Sabre Hotel Aggregator

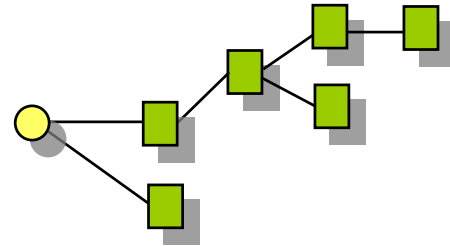

## End-to-end Business Processes

- DSL Service Provisioning
- Employee Onboarding
- Order-to-Cash

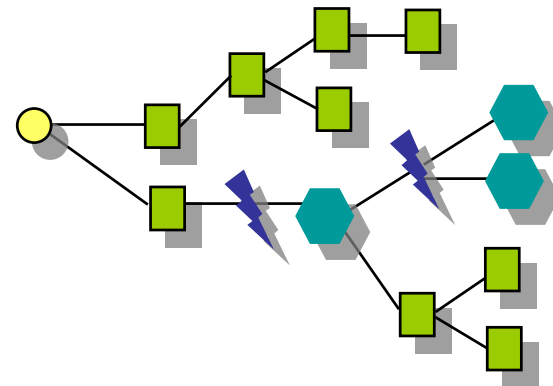

# Example | Retek - Financials Integration

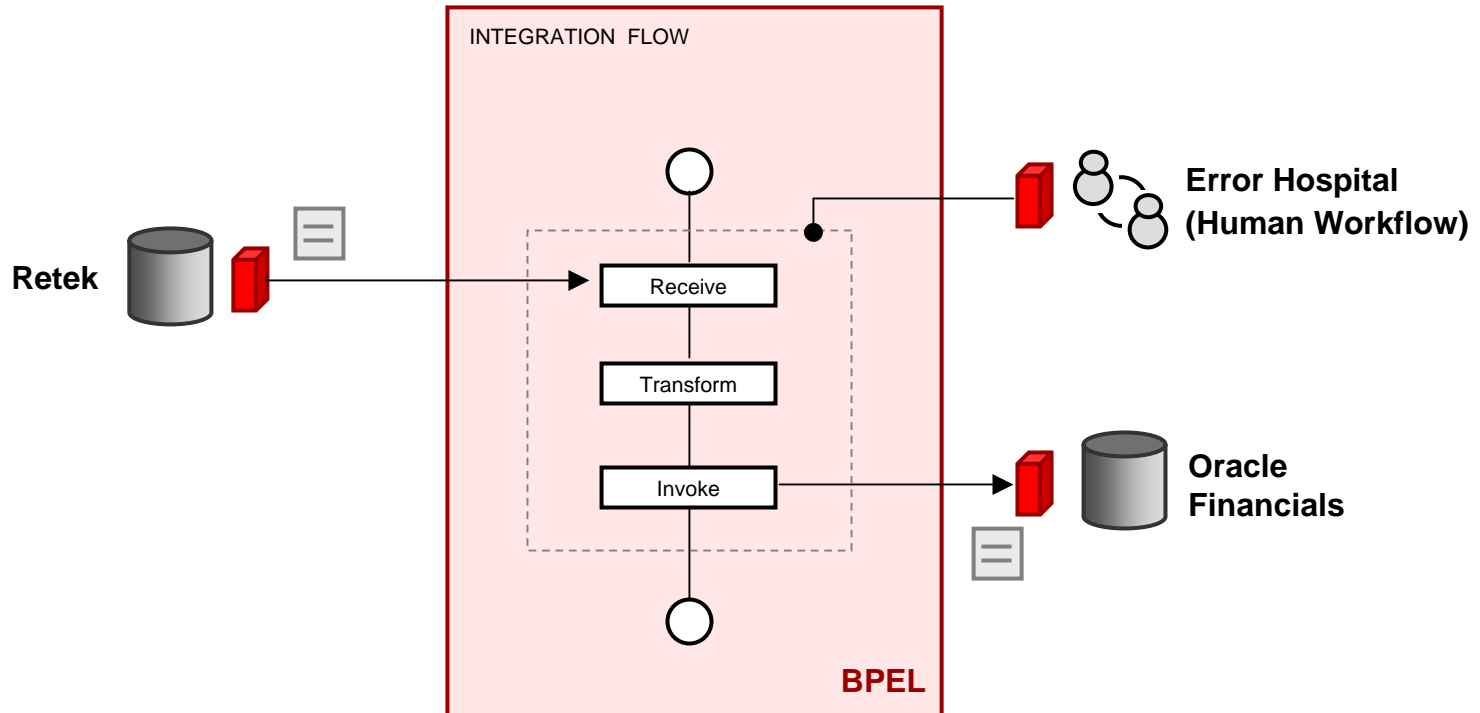



# Example | DSL Service Provisioning

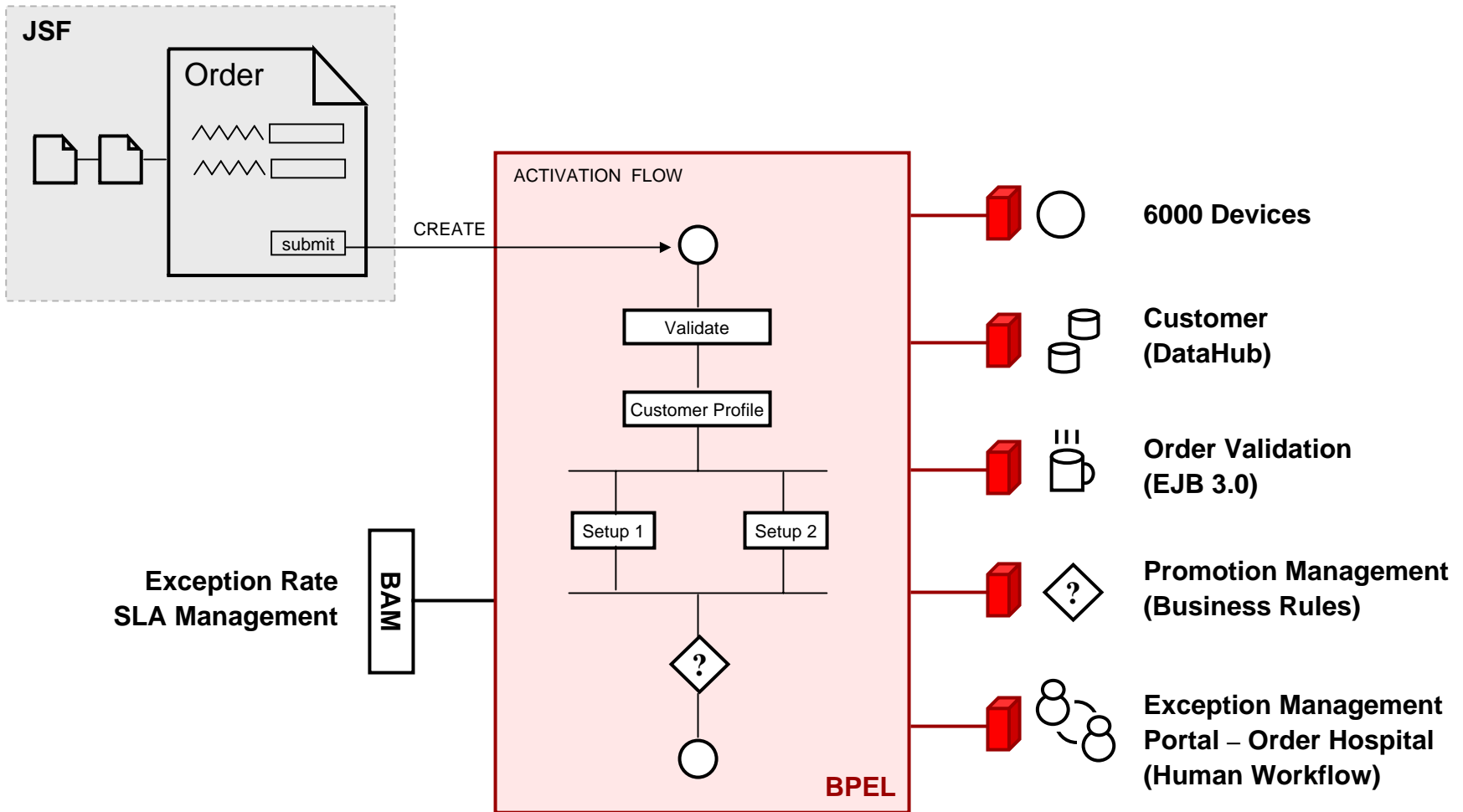

# SOA

## Different Value for Different People



Business User



Architects



IT Manager

# SOA for Business Users



- **Time-to-Market**  
Deliver new products and services faster
- **Variance**  
Customize business processes for channels, customers, suppliers, etc.
- **Insight**  
Monitor and react to key performance indicators in real-time
- **Six Sigma**  
Automate unnecessary manual steps and exceptions

# SOA for Developers and Architects

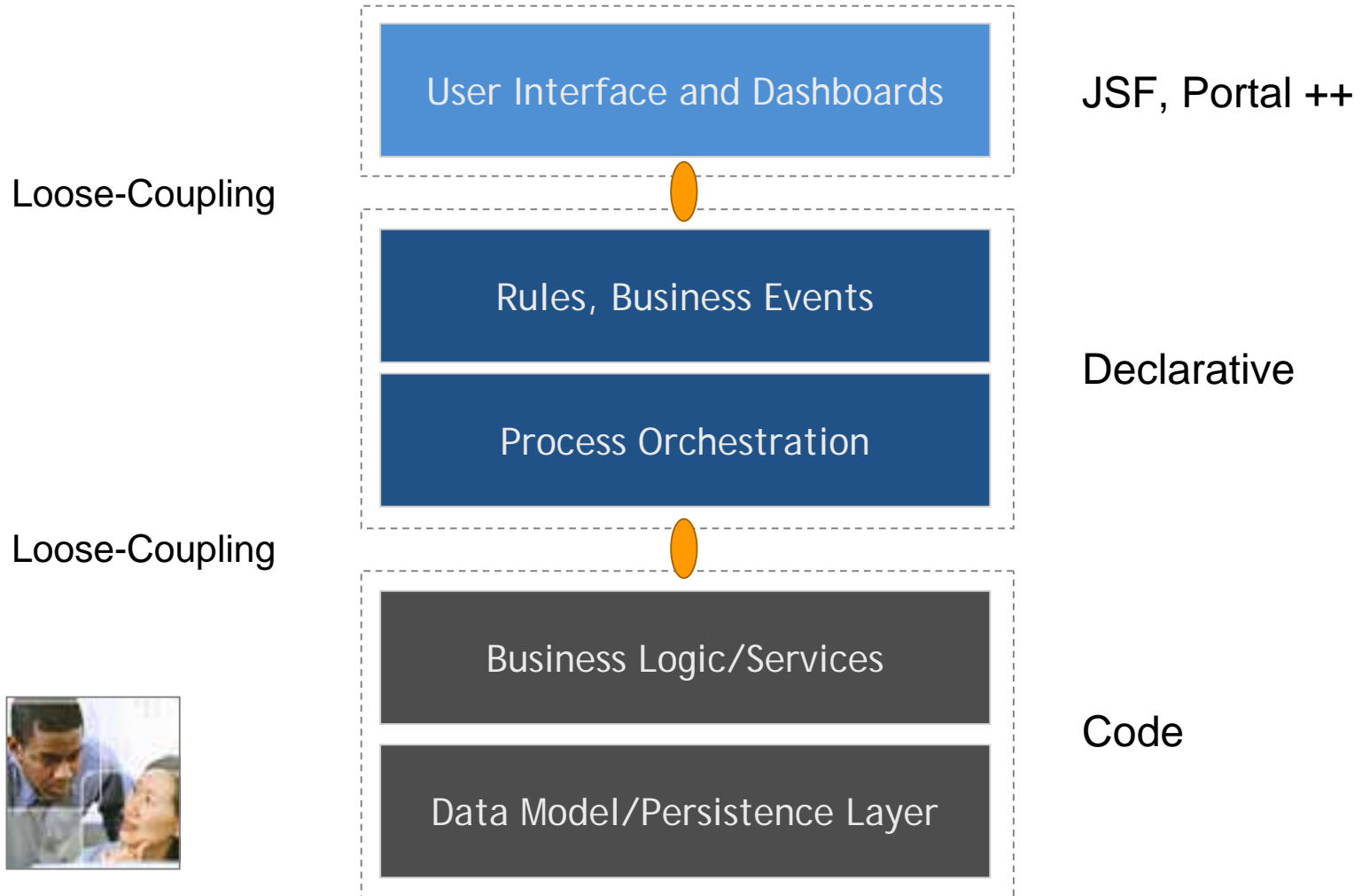

# SOA for Managers

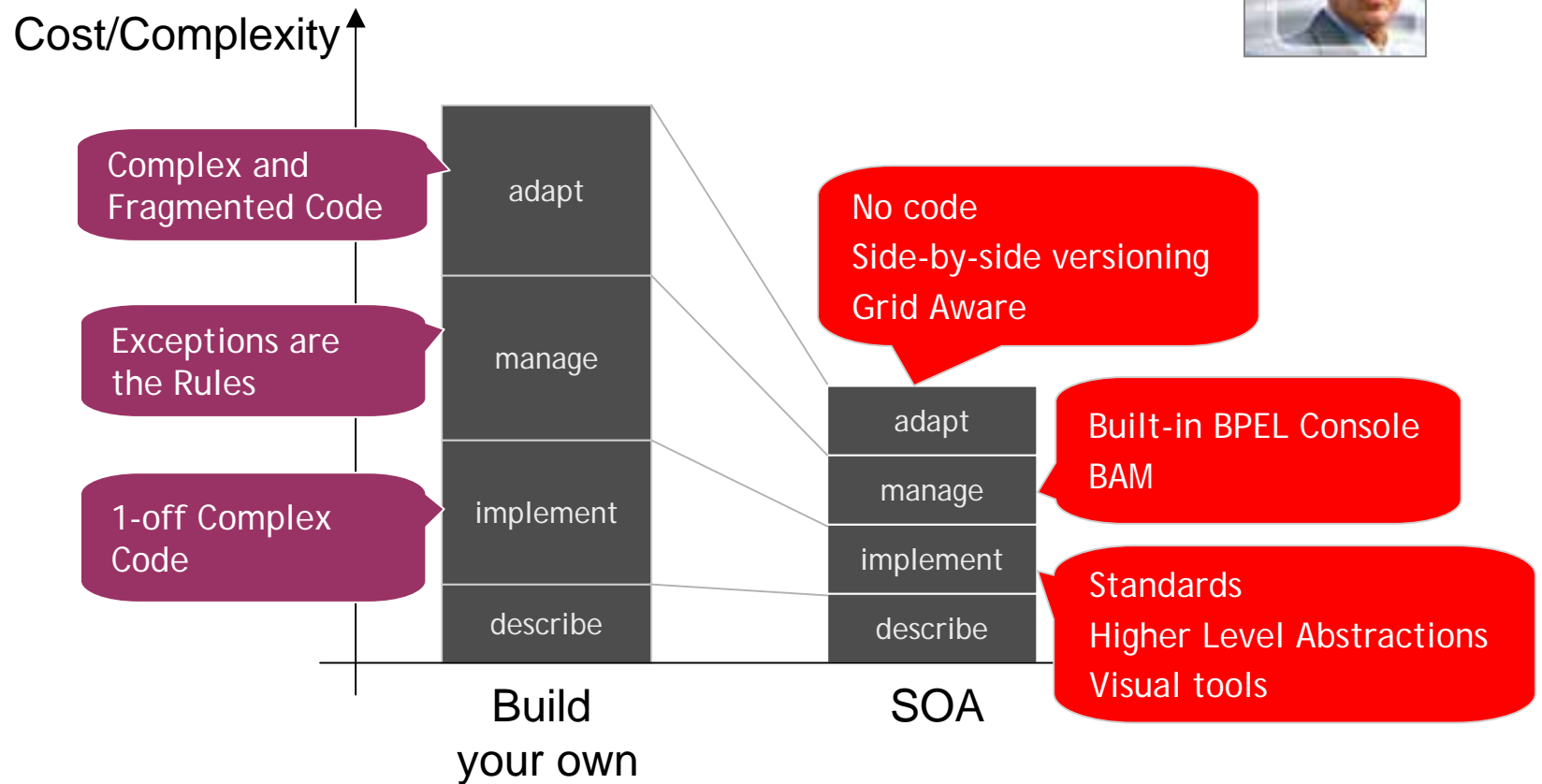

# SOA

## Best Practices

# The Path to a Successful SOA Project

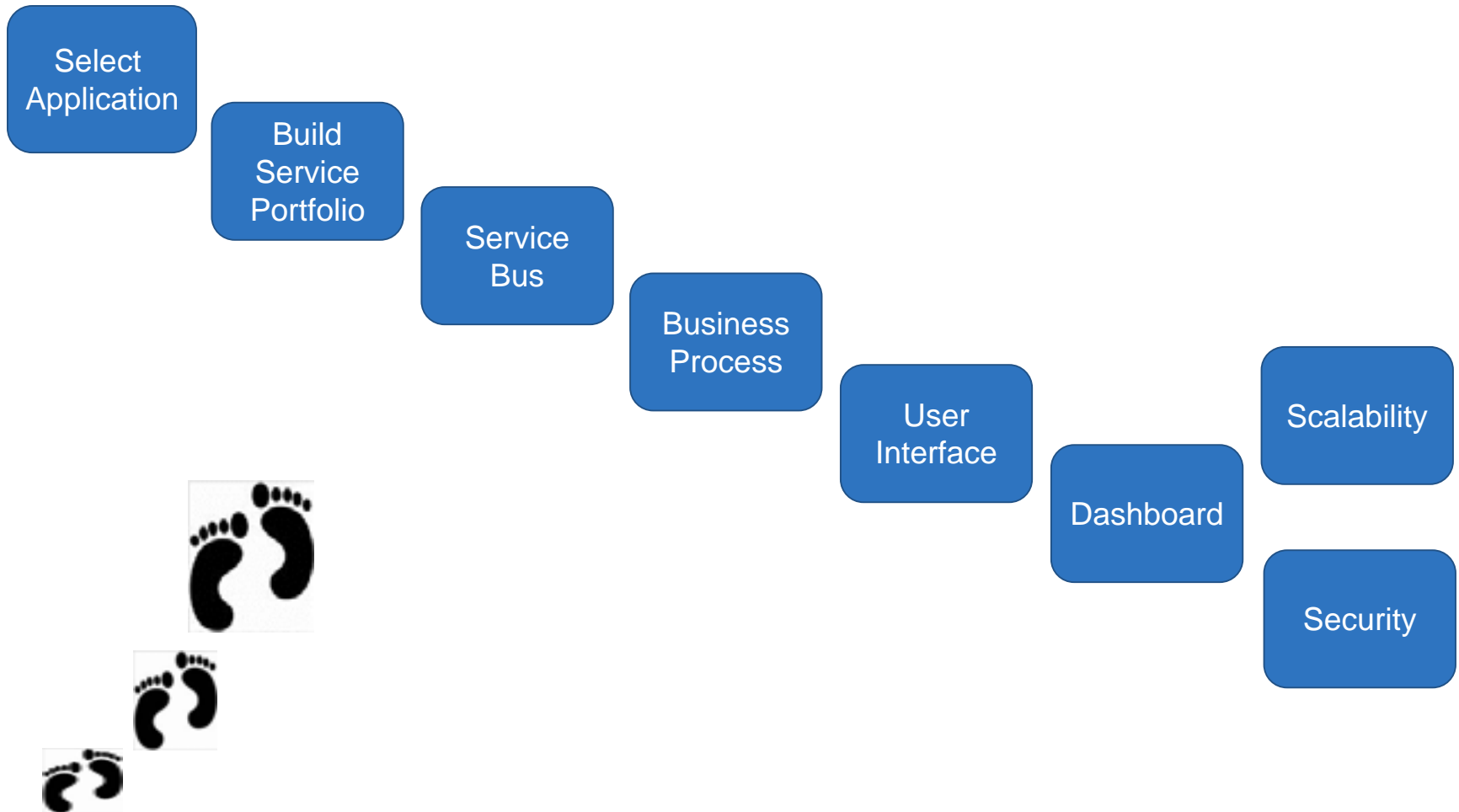



## 0 | Select An Application

### CRITERIA

- Broken Process
- Lack of Visibility
- Variance
- Integration Points
- Clear Metrics





# 1 | Build Portfolio of Services

## - BEST PRACTICES

- Contract/Interface First
- Coarse Grain Documents
- Asynchronous Interactions
- Undo/Cancel Operations
- Versioning
- WS-I, Wrapped Document Style
- WSIF Binding to Java, JCA

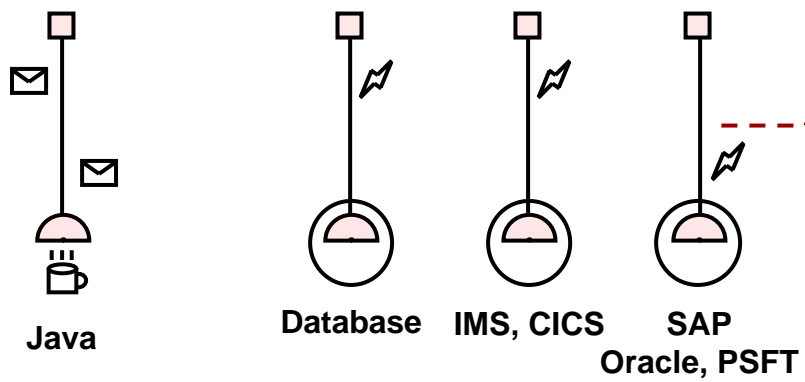



## 2 | Wire Through An Enterprise Service Bus

### BEST PRACTICES

- UDDI Registry
- JCA Adapters
- Integration with Policy Management Framework
- Service Virtualization Logical Naming
- Differed, Reliable Delivery (Configurable)

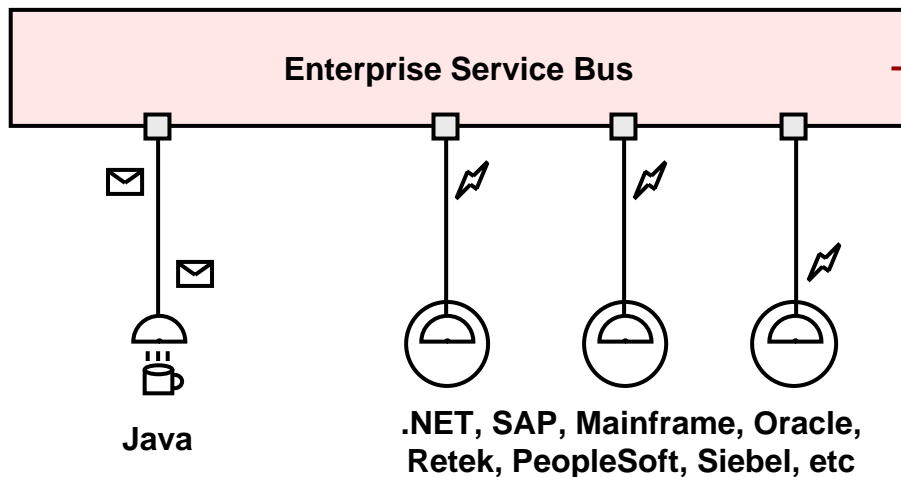



## 3 | Orchestrate into End-to-End Processes

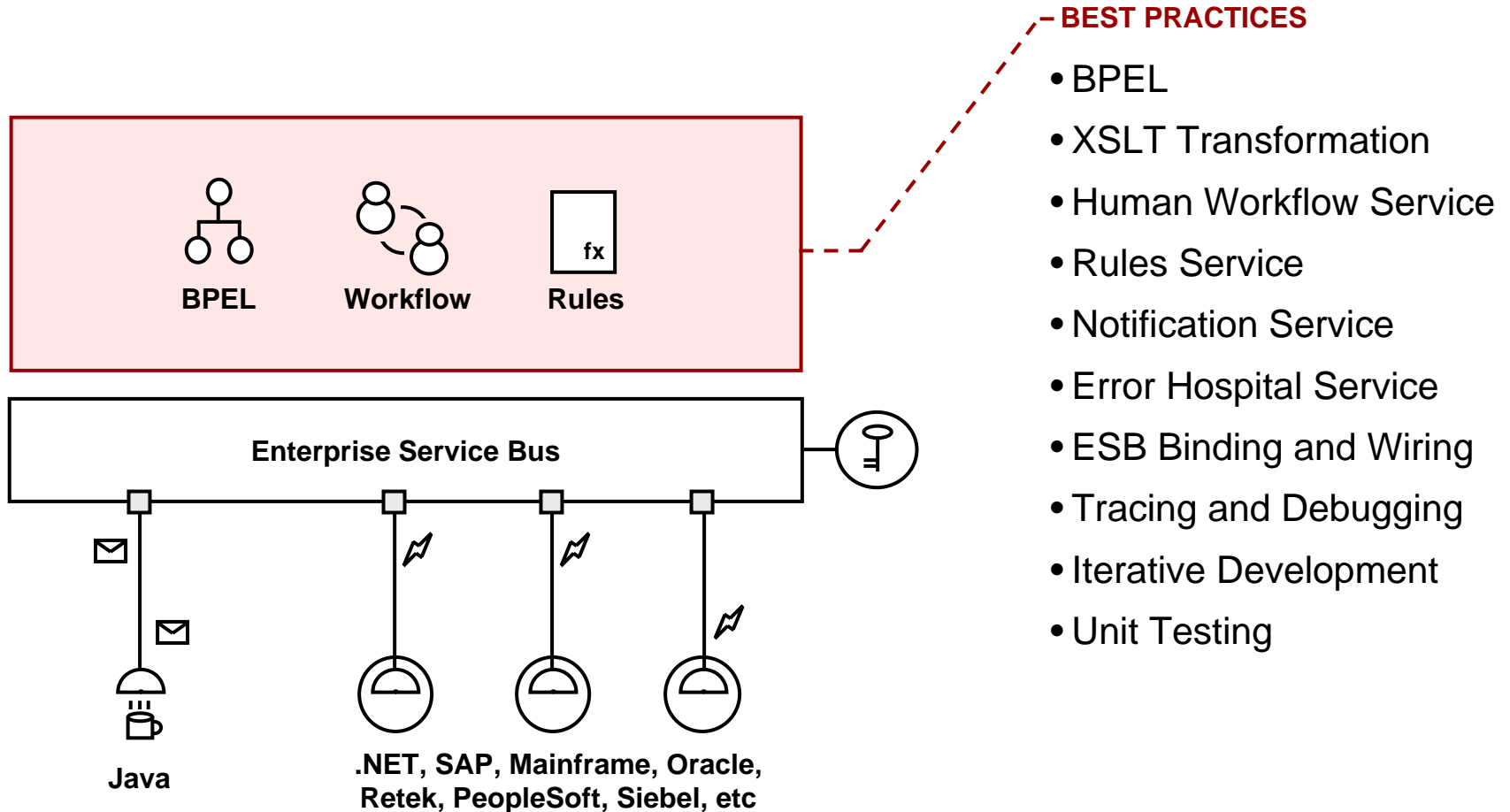



# 4 | Expose through Rich User Interfaces

Portal, JSF Applications, .NET, Microsoft Office

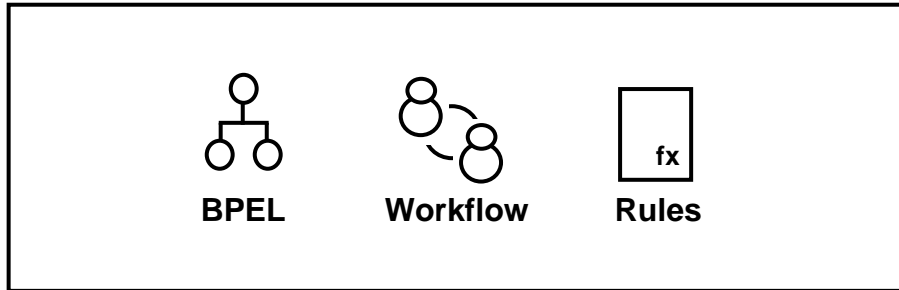

Enterprise Service Bus

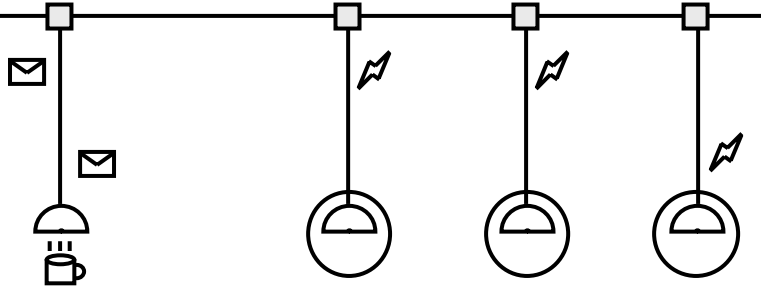

Java

.NET, SAP, Mainframe, Oracle, Retek, PeopleSoft, Siebel, etc

**BEST PRACTICES**

- JSF
- WSRP, JSR-168



# 5 | Deliver Real-time Dashboards

Portal, JSF Applications, .NET, Microsoft Office

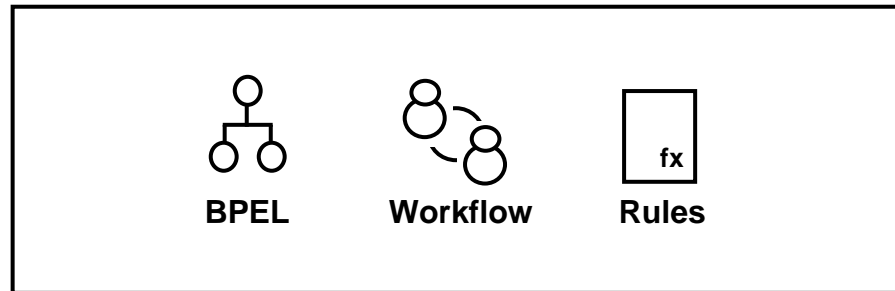

Enterprise Service Bus

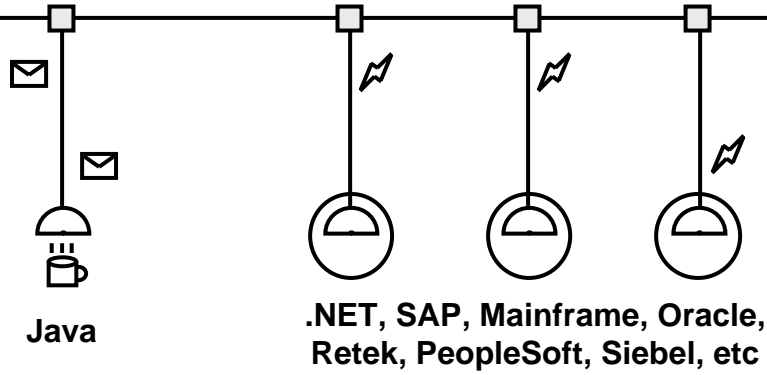

## BEST PRACTICES

- KPI First
- Sensors to Collect Events without Business Process Changes
- Real-time Dashboard
- Alert/Actions (Fusion Effect)



## 6 | Secure Interactions

Portal, JSF Applications, .NET, Microsoft Office

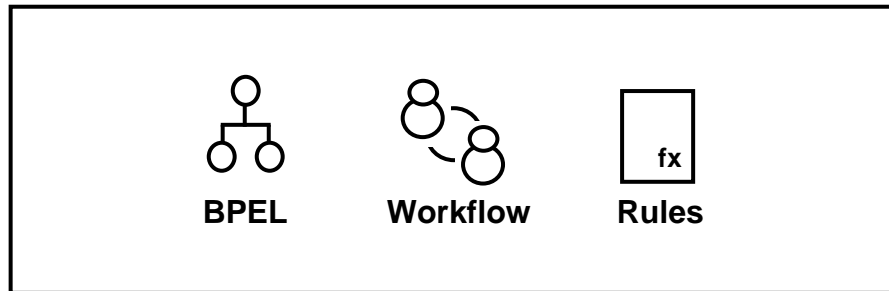

Enterprise Service Bus

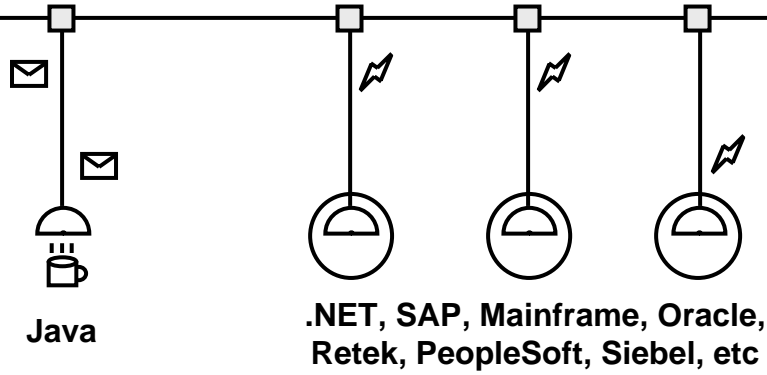

### - BEST PRACTICES

- WS-Policy, WS-Security
- Change Policy without Changing Endpoint
- Integrated with ESB (Multi-binding Support)
- Agent and Gateway Mode
- Support for Java and .NET



# 7 | Scale On Demand

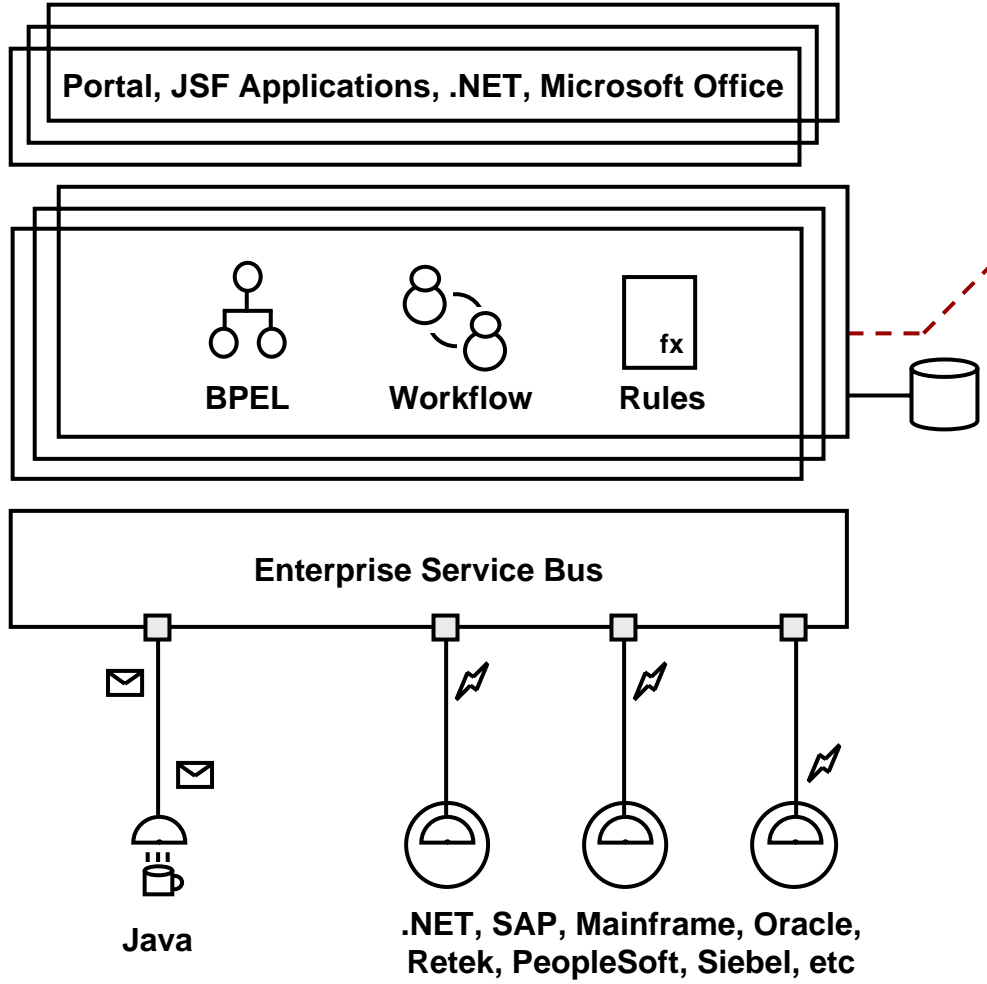

## BEST PRACTICES

- Asynchronous Interactions
- Support for Large XML Documents
- Clustering-Friendly
- JCA and Java Binding
- Batch API

# Built-to-Change